

SG 4840

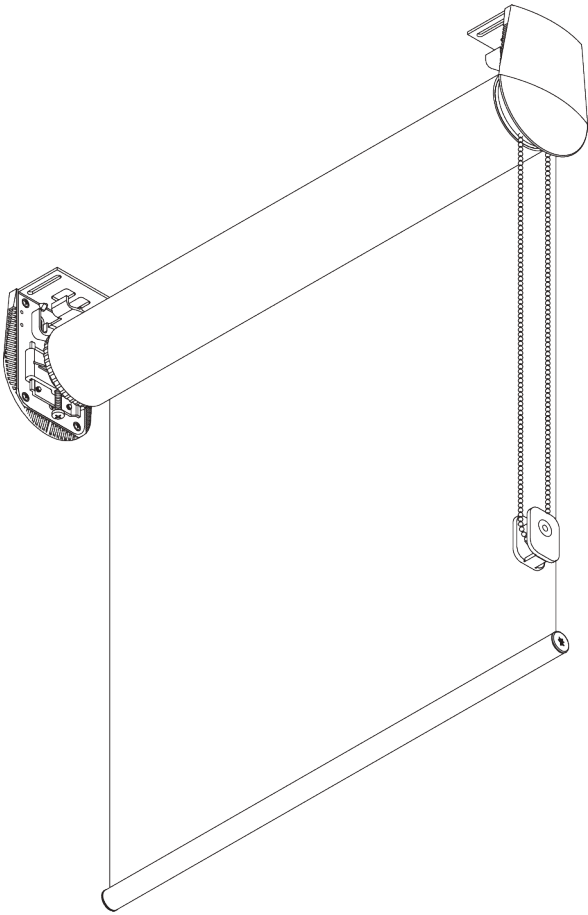

PRODUCT INFORMATION

- **Operation:** chain
- **Range:** L
- **Fitting:** ceiling, wall, recess
- **Colours:** white RAL 9016; special colours or anodised aluminum possible
- **Fabrics:** refer to Silent Gliss fabric collection

Features:

- Stainless steel bead chain
- Stainless steel brackets, adjustable for vertical alignment of fabric

SYSTEM SPECIFICATIONS

A. SYSTEM DIMENSIONS



Tube SG 4957: 5 m
Tube SG 4901: 4 m



50 cm

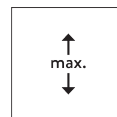

Tube SG 4957: 3.75 m
Tube SG 4901: 6 m



15 m²

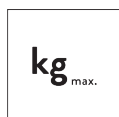

Tube SG 4957: 9.5 kg
Tube SG 4901: 12.5 kg

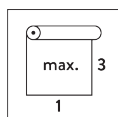

Recommended width /
height ratio
max. 1:3

Maximum surface area

		A →								
		2 m	2.5 m	3 m	3.5 m	4 m	4.5 m	5 m		
B ↓	2 m	●	●	●	●	○	○	○	 ● SG 4901 (ø 80 mm)	
	2.5 m	●	●	●	●	○	○	○		
	3 m	●	●	●	●	○	○	○		
	3.5 m	●	●	●	●	○			 ○ SG 4957 (ø 110 mm)	
	4 m	●	●	●	●					
	4.5 m	●	●	●						
	5 m	●	●	●						
	5.5 m	●	●		max. 15 m ²					
6 m	●	●								

B. PROFILE

Profile information

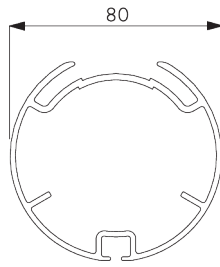

SG 4901

Tube ø 80 mm

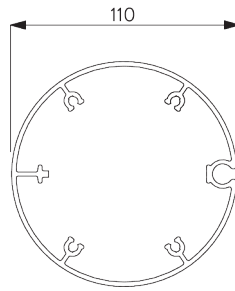

SG 4957

Tube ø 110 mm

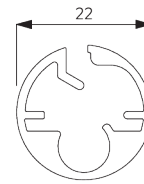

SG 10760

Bottom bar

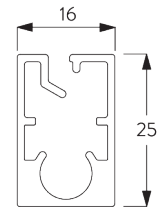

SG 10770

Bottom bar

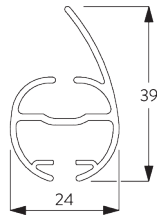

SG 4903

Bottom bar

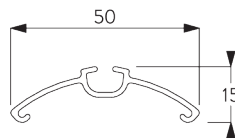

SG 4902

Profile

C. HOW TO MEASURE

incl. bracket covers
(15 mm)

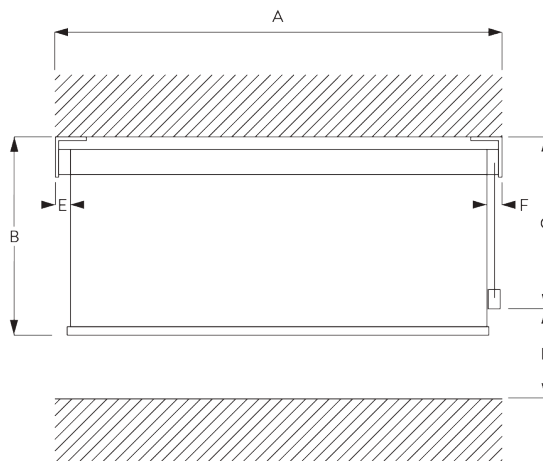

A: System width

B: System height

C: Chain height

D: Safety Retainer SG 10731 min. 150 cm above floor

Tube SG 4901 (ø 80 mm):

E: Light gap: 44 mm

F: Light gap operation side: 40 mm

Tube SG 4957 (ø 110 mm):

E: Light gap: 42 mm

F: Light gap operation side: 42 mm

Note:

All measurements include 15 mm for bracket cover per side!
These can be omitted to reduce side light gaps.

D. SPECIFICATION TEXT

Silent Gliss SG 4840 chain operated roller blind system for very heavy duty applications. Assembled complete with anodised aluminium headrail. Smooth light operation thanks to the planetary gear and no slippage due to the integrated brake. Incorporates Silent Gliss patented Quick Twist for easy on-site adjustment of the headrail to prevent fabric roll off. Fix to wall/ceiling/inside recess with stainless steel bracket combination set SG 4944 incorporating hook on plates to take weight of blind during installation. Optional bracket covers. Fabrics to be selected from Silent Gliss range.

FITTING

A. FITTING INFORMATION

For detailed fitting information, visit the Silent Gliss website.

Fixing points



*30 mm without cover
*43 mm with cover

Adjustable brackets (for vertical adjustments)

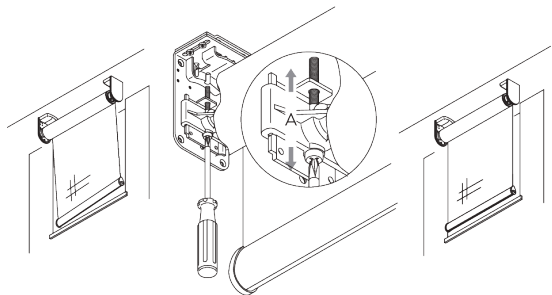

Vertical adjustment of fabric to the window frame.

B. CEILING FITTING

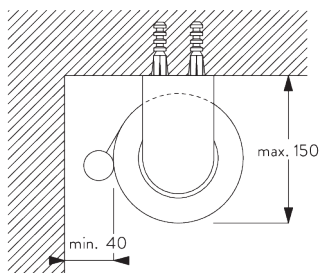

Tube SG 4901 (ø 80 mm)

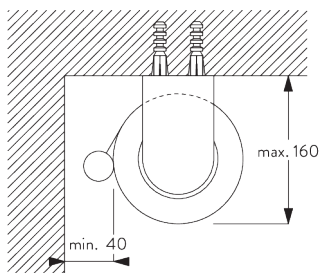

Tube SG 4957 (ø 110 mm)

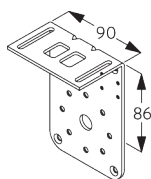

SG 4904
Bracket (set SG 4949)

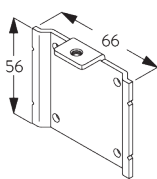

SG 4906
Plate (set SG 4949)

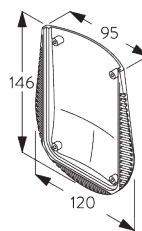

SG 4956
Bracket cover

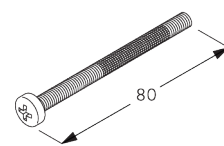

SG 4966
Special screw (set SG 4949)

C. WALL FITTING

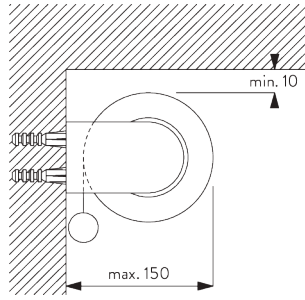

Tube SG 4901 (ø 80 mm)

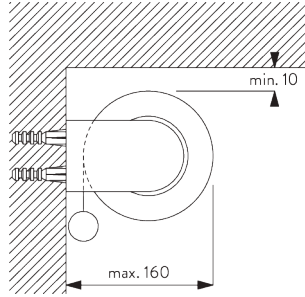

Tube SG 4957 (ø 110 mm)

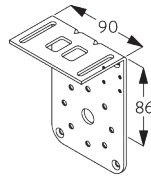

SG 4904
Bracket (set SG 4949)

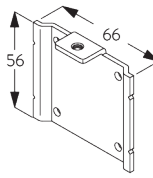

SG 4906
Plate (set SG 4949)

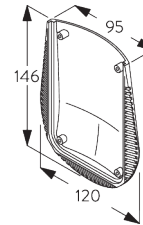

SG 4956
Bracket cover

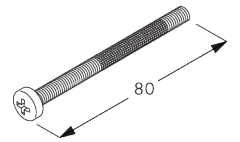

SG 4966
Special screw (set SG 4949)

D. RECESS FITTING

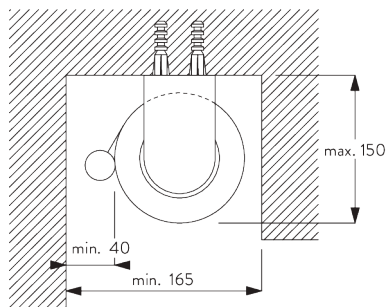

Tube SG 4901 (ø 80 mm)

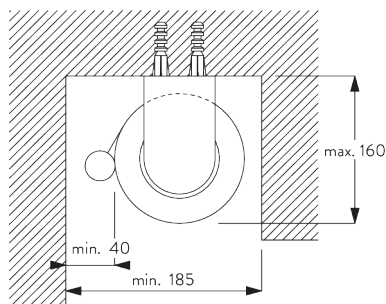

Tube SG 4957 (ø 110 mm)

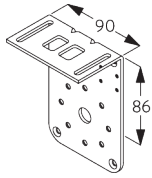

SG 4904
Bracket (set SG 4949)

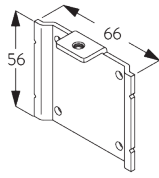

SG 4906
Plate (set SG 4949)

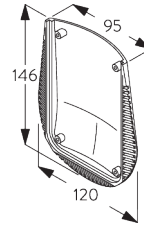

SG 4956
Bracket cover

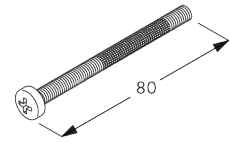

SG 4966
Special screw (set SG 4949)

**E. FITTING WITH
SIDE GUIDE
OPTION**

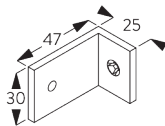
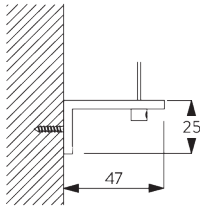

SG 3036
Bracket 47 mm

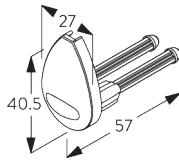

SG 4944
Side guide end cover

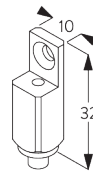

SG 4946
Side guide wire rope fastener

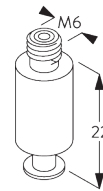

SG 4947
Side guide wire rope fastener

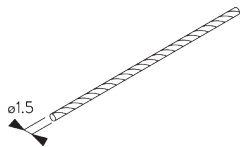

SG 4948
Side guide wire ø 1.5 mm

SYSTEM OPTIONS

A. FABRIC ROLL-OFF

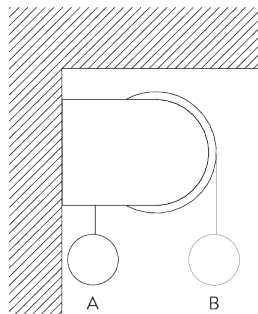
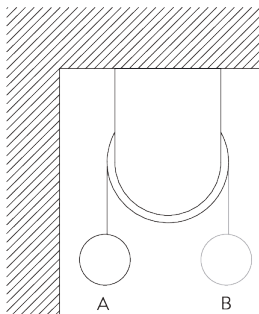

A: Fabric roll-off window side (standard)
B: Fabric roll-off room side (option)

B. SIDE GUIDES

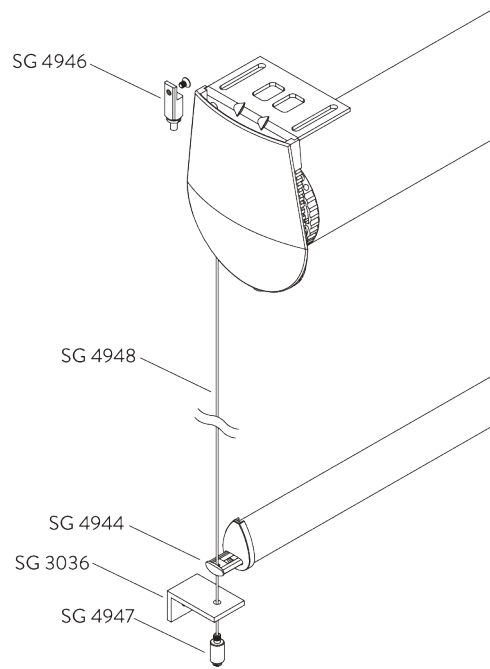

Additional parts:

- 2x SG 3036 Bracket 47 mm
- 2x SG 4944 Side guide end cover
- 2x SG 4946 Side guide wire rope fastener
- 2x SG 4947 Side guide wire rope fastener
- 2x SG 4948 Side guide wire \varnothing 1.5 mm

Note:

- Light gaps increase when side-guide option is used
- Up to 15° from vertical

C. HOOK-IN INSTALLATION PLATES

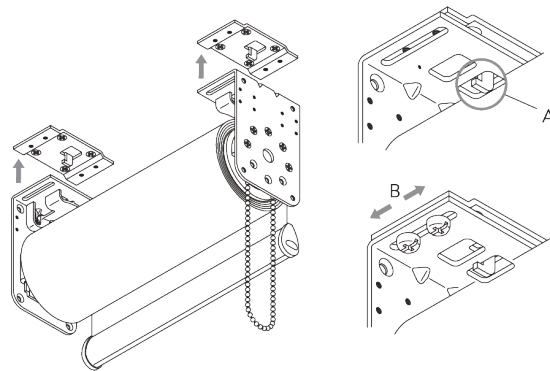

- A: Hook-in plates SG 4972 take the weight of the blind
 B: Brackets sideways adjustable by up to 18 mm

D. ADJUSTABLE END STOP

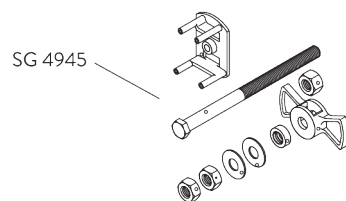

PARTS

A. STANDARD PARTS

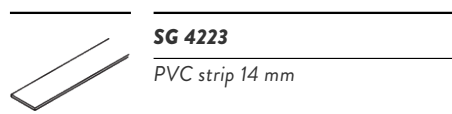

SG 4223
PVC strip 14 mm

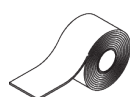

SG 4226
Double tape 30 mm



SG 4845
Bead chain metal ø 4.5 mm



SG 4901
Tube ø 80 mm



SG 4902
Profile

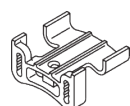

SG 4908
End stop

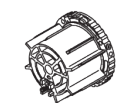

SG 4914
Tube adapter

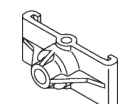

SG 4915
Support

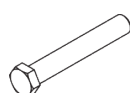

SG 4939
Shaft

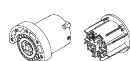

SG 4941
Chain drive set

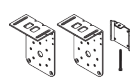

SG 4949
Bracket set



SG 4956
Bracket cover

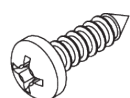

SG 10503
Pan head screw 3.5x13

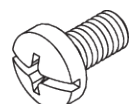

SG 10505
Pan head screw Freedrive M4x8

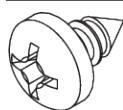

SG 10507
Pan head screw 3.5x6.5

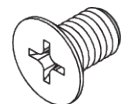

SG 10509
Countersunk head screw M5x8



SG 10731
Child safety retainer set



SG 10760
Bottom bar



SG 10761
End cover

B. OPTIONAL PARTS



SG 2006
Bottom bar 28x3 mm

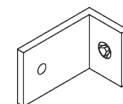

SG 3036
Bracket 47 mm



SG 4903
Bottom bar

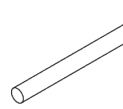

SG 4943
Rod ø 4 mm

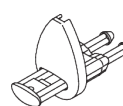

SG 4944
Side guide end cover

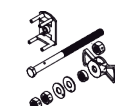

SG 4945
End stop set



SG 4946
Side guide wire rope fastener



SG 4947
Side guide wire rope fastener



SG 4948
Side guide wire ø 1.5 mm

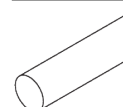

SG 4951
Bottom weight ø 8 mm



SG 4957
Tube ø 110 mm

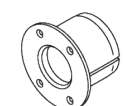

SG 4958
Tube adapter

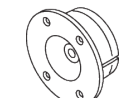

SG 4961
Tube adapter

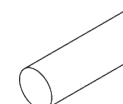

SG 4963
Rod ø 6 mm

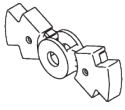

SG 4965

End stop flange

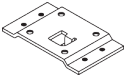

SG 4972

Installation plate

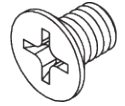

SG 10502

Countersunk head screw M4x6

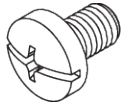

SG 10504

Pan head screw Freedrive M5x8

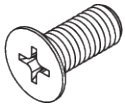

SG 10508

Countersunk head screw M5x12

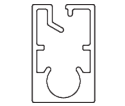

SG 10770

Bottom bar



SG 10771

End cover



SG 11178

End cover

